



OCEAN  
OBSERVATORIES  
INITIATIVE

# OOI Coastal Endurance Equipment Engineering Considerations



OCEANOBSERVATORIES.ORG



**Jonathan Fram**  
Endurance Array Project Manager  
OSU Associate Professor Senior Research





# Gliders

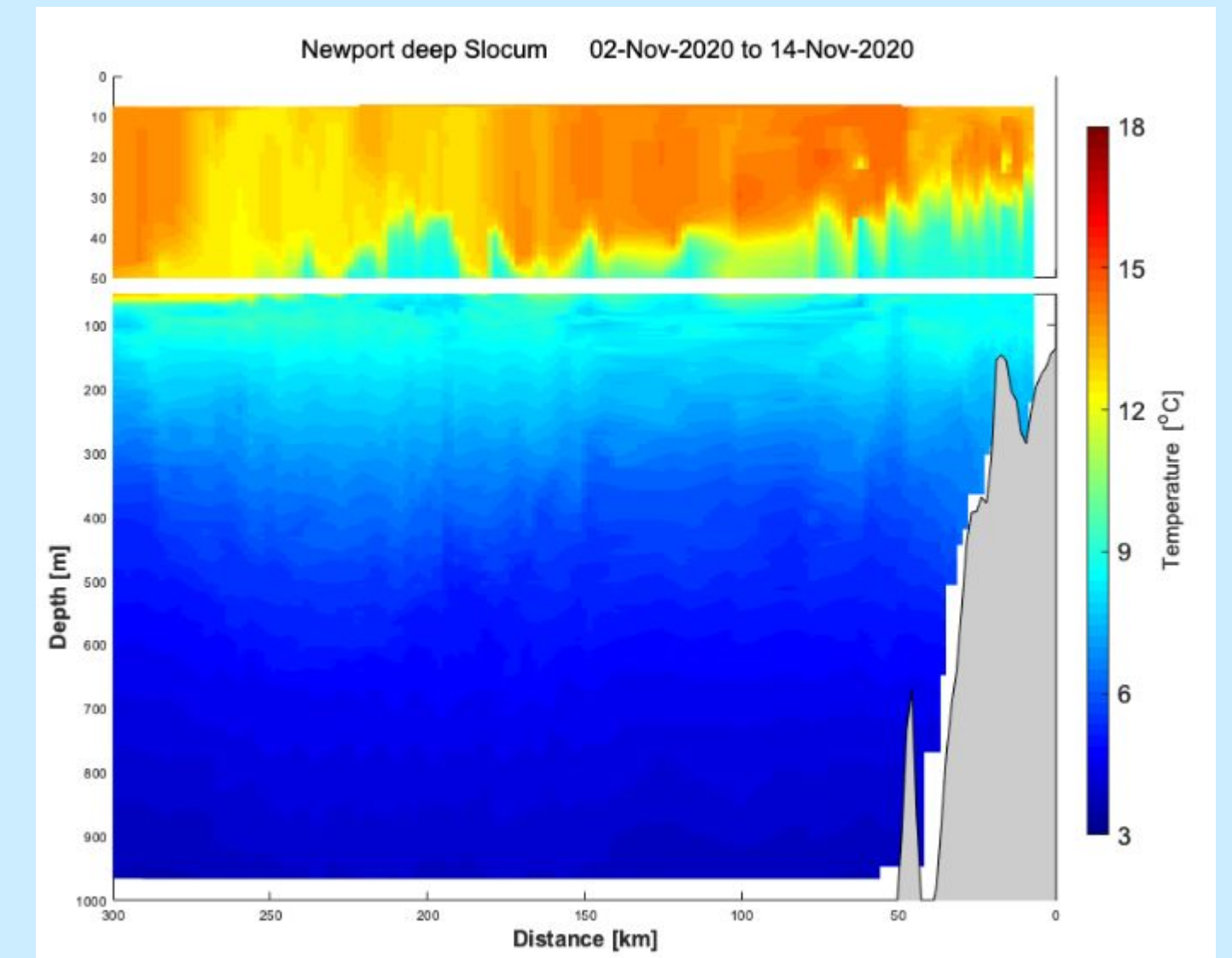
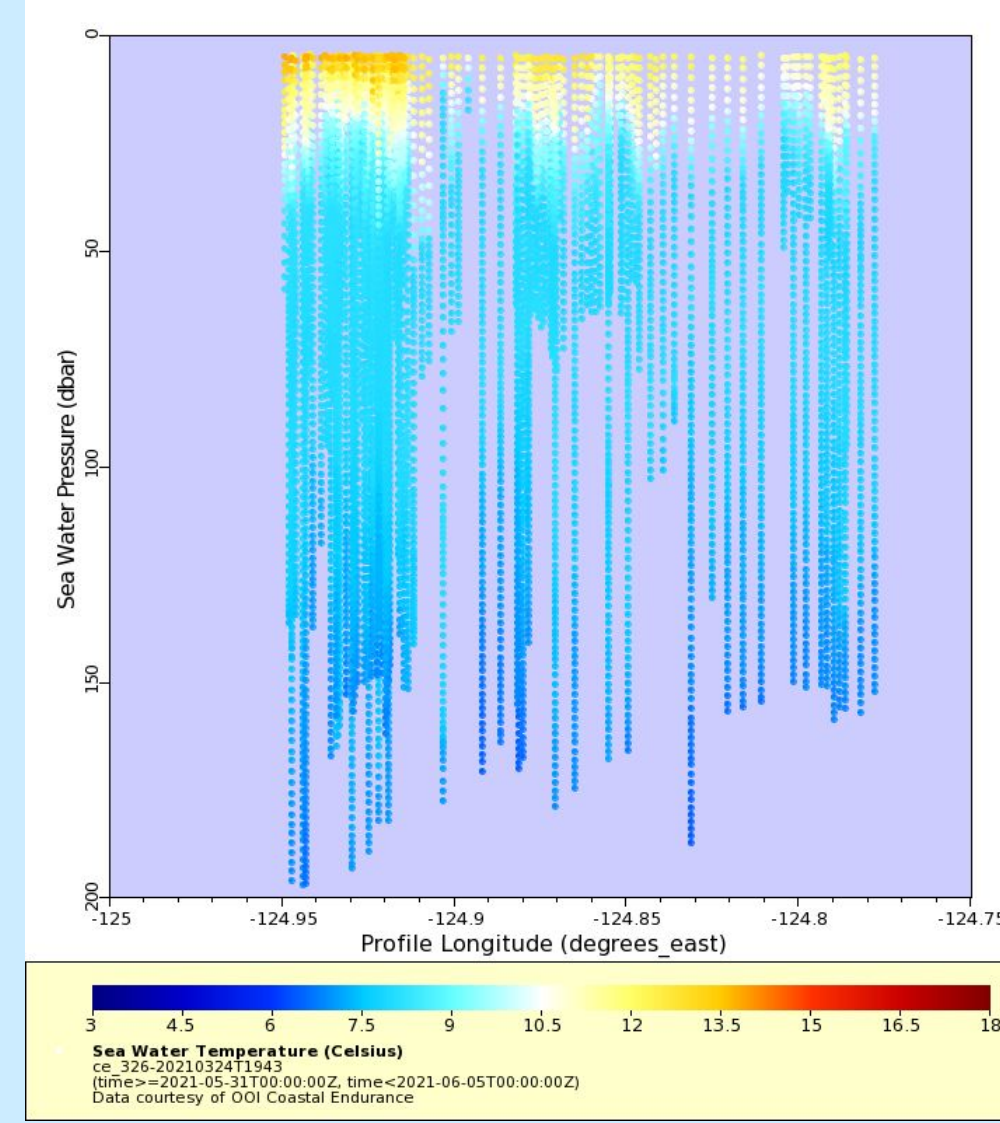

OCEANOBSERVATORIES.ORG



Raw data from <https://gliders.ioos.us/erddap> Data from <http://nvs.nanoos.org/GliderOoiNewportDeep>

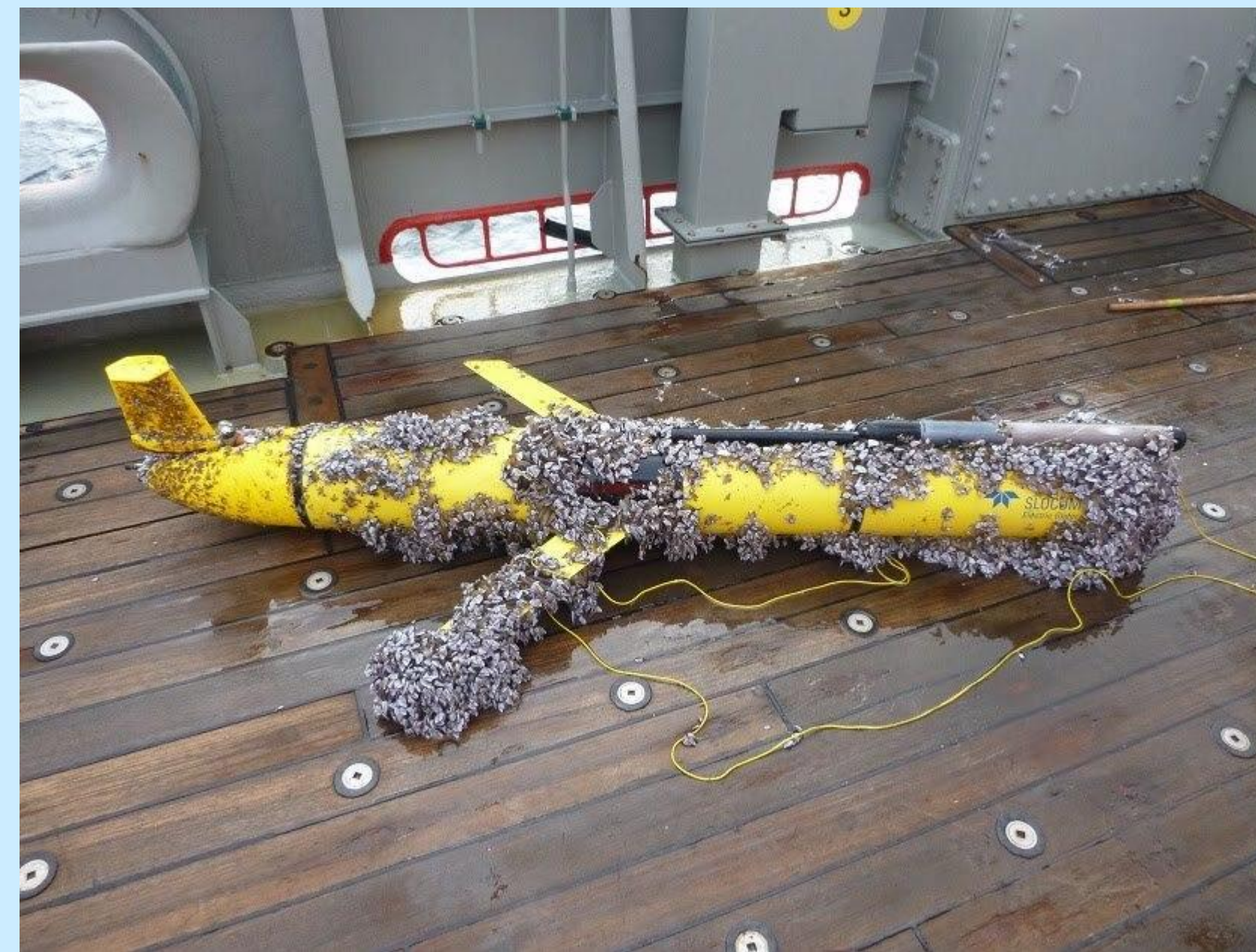

Glider covered in barnacles





# Wire Following Profiler Mooring

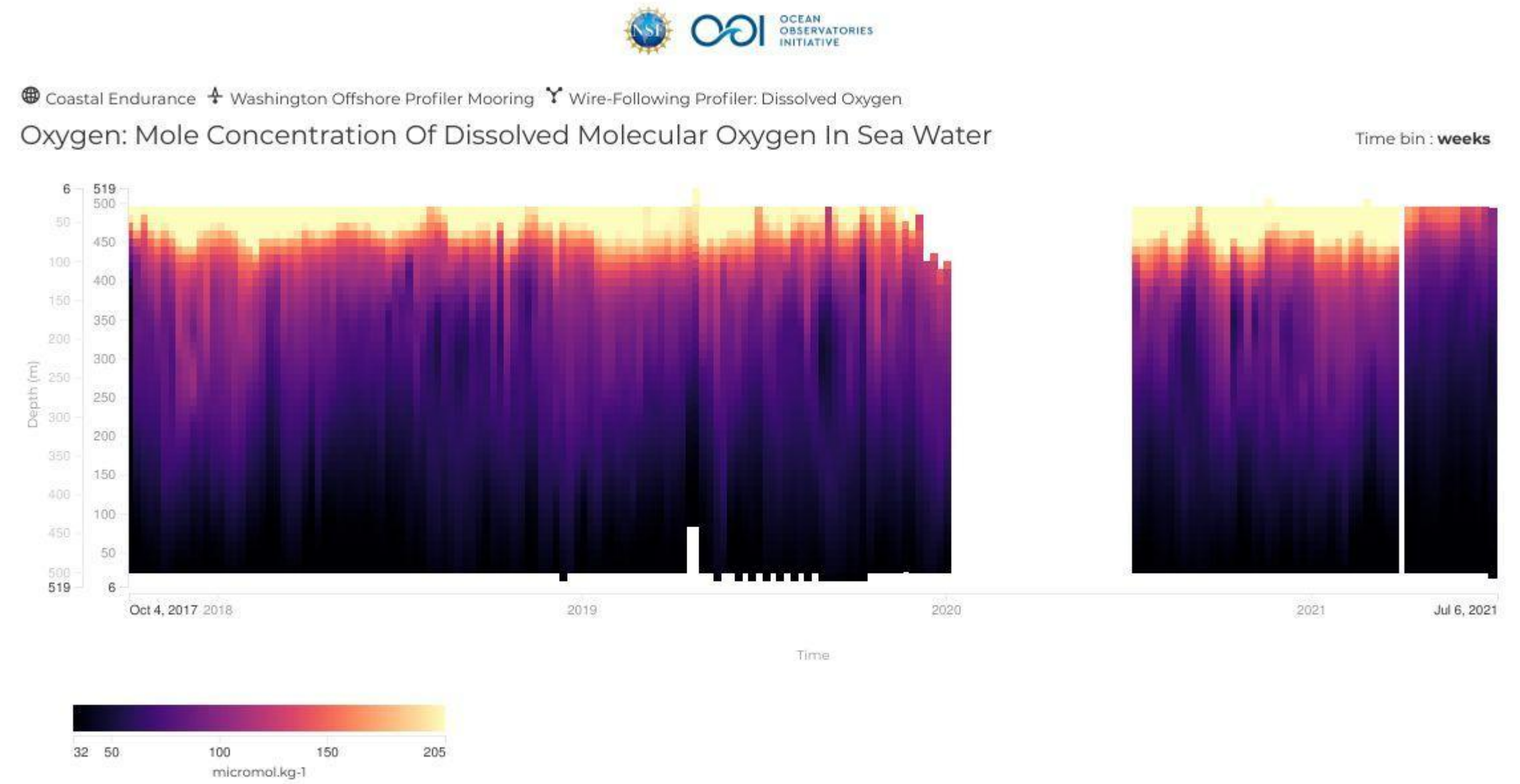
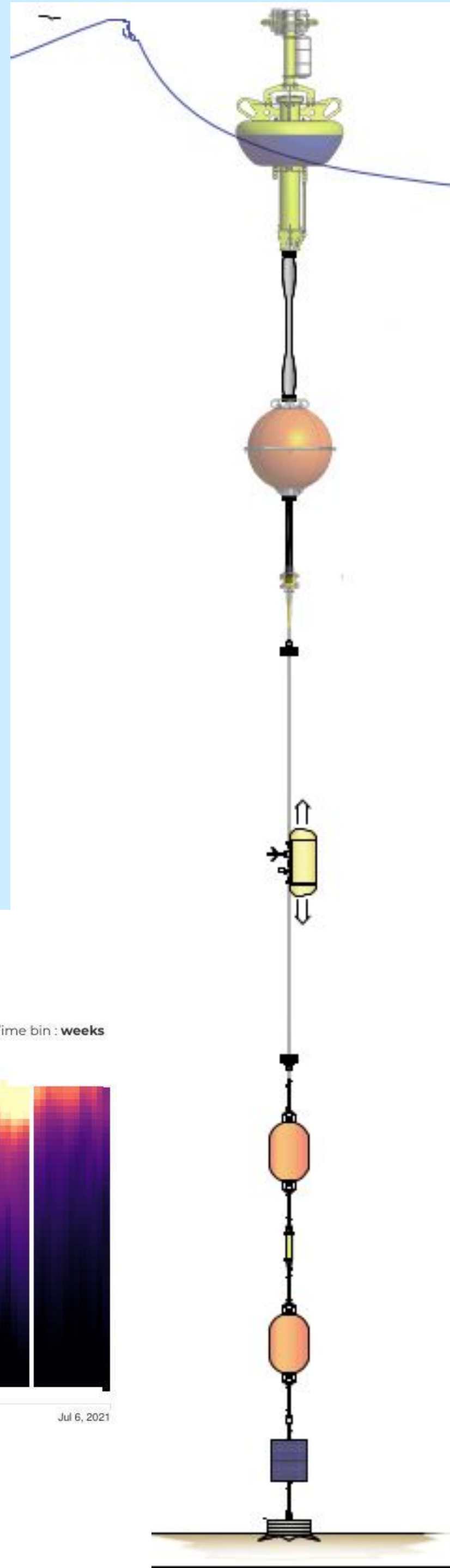
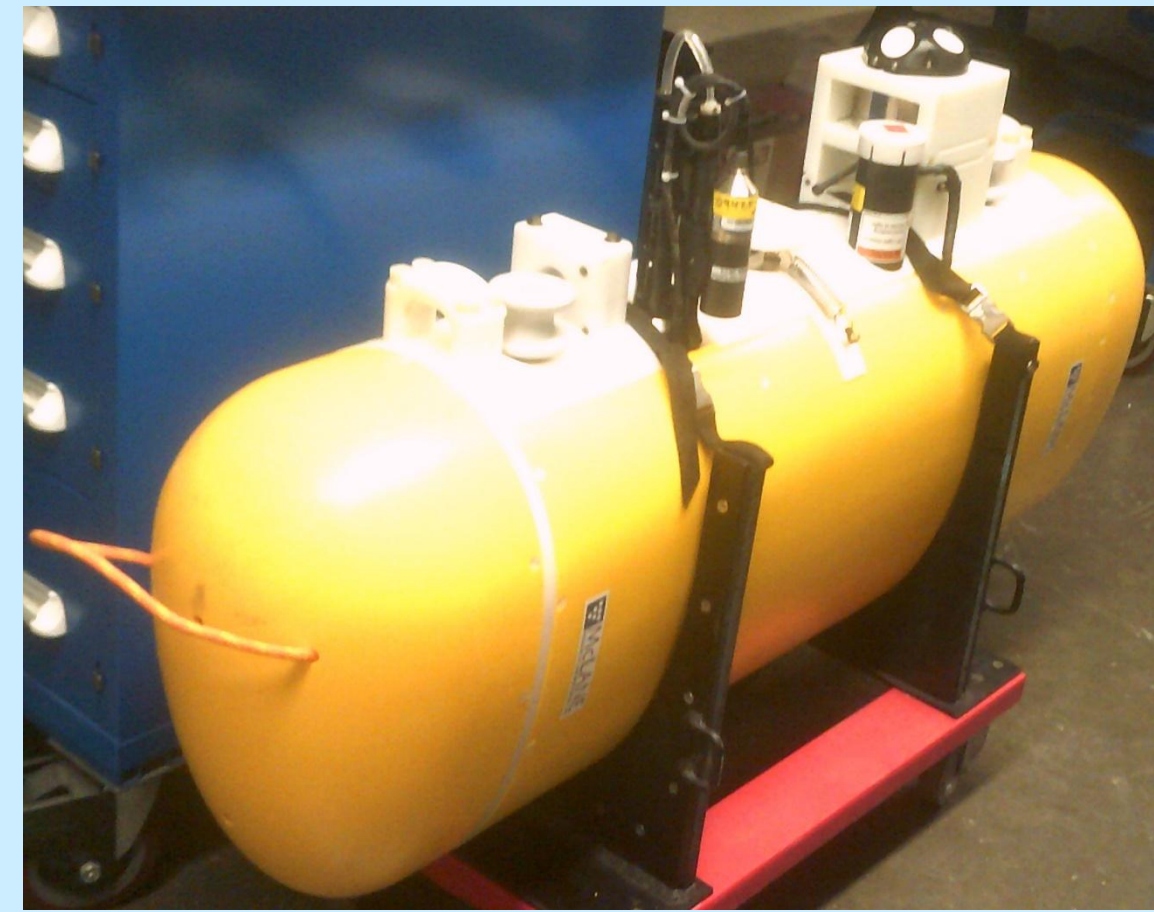



# Coastal Surface Piercing Profilers

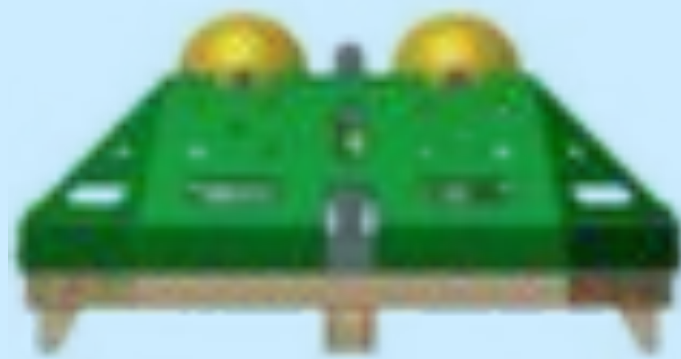
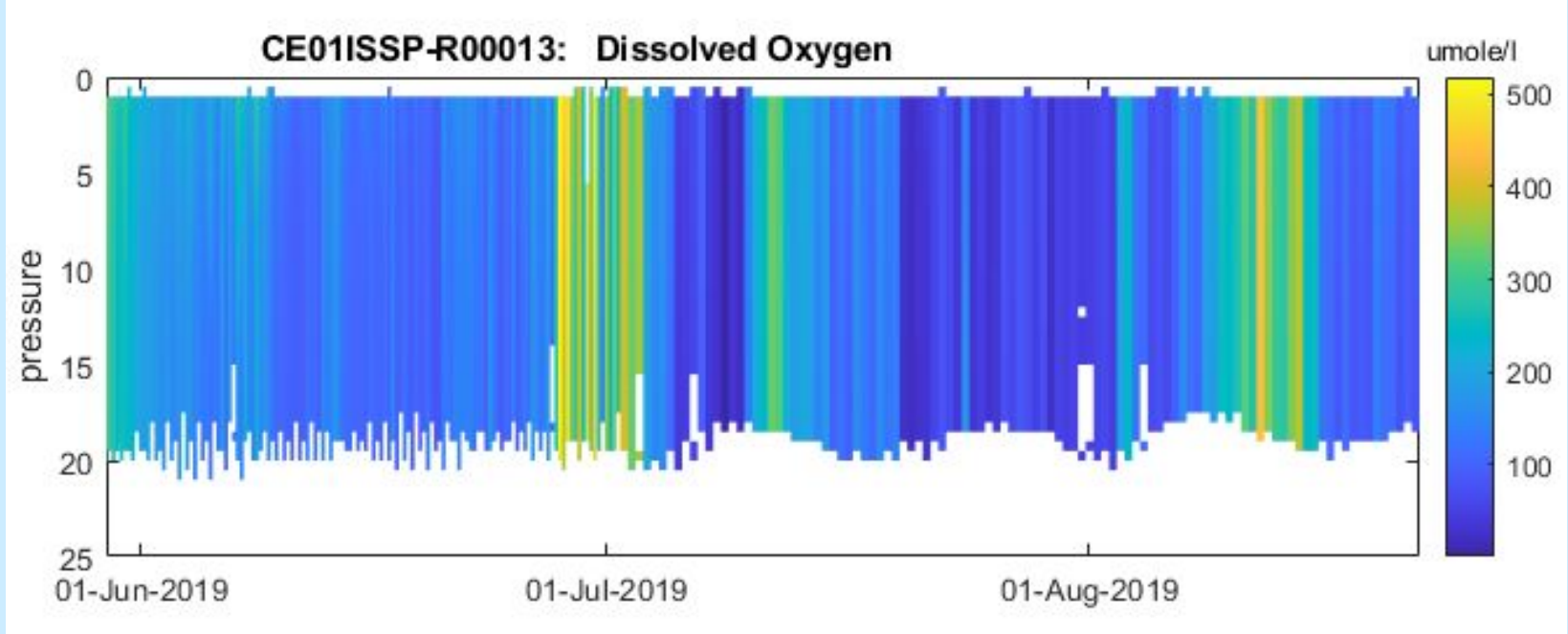

Copper and wipers prevent sensor biofouling

Protected Oxygen sensor

UV light prevents biofouling on sensors

Protected 7-color light sensor





# Inshore Submersible Surface Moorings

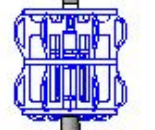
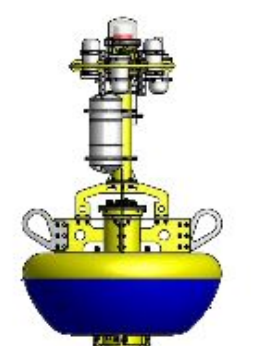
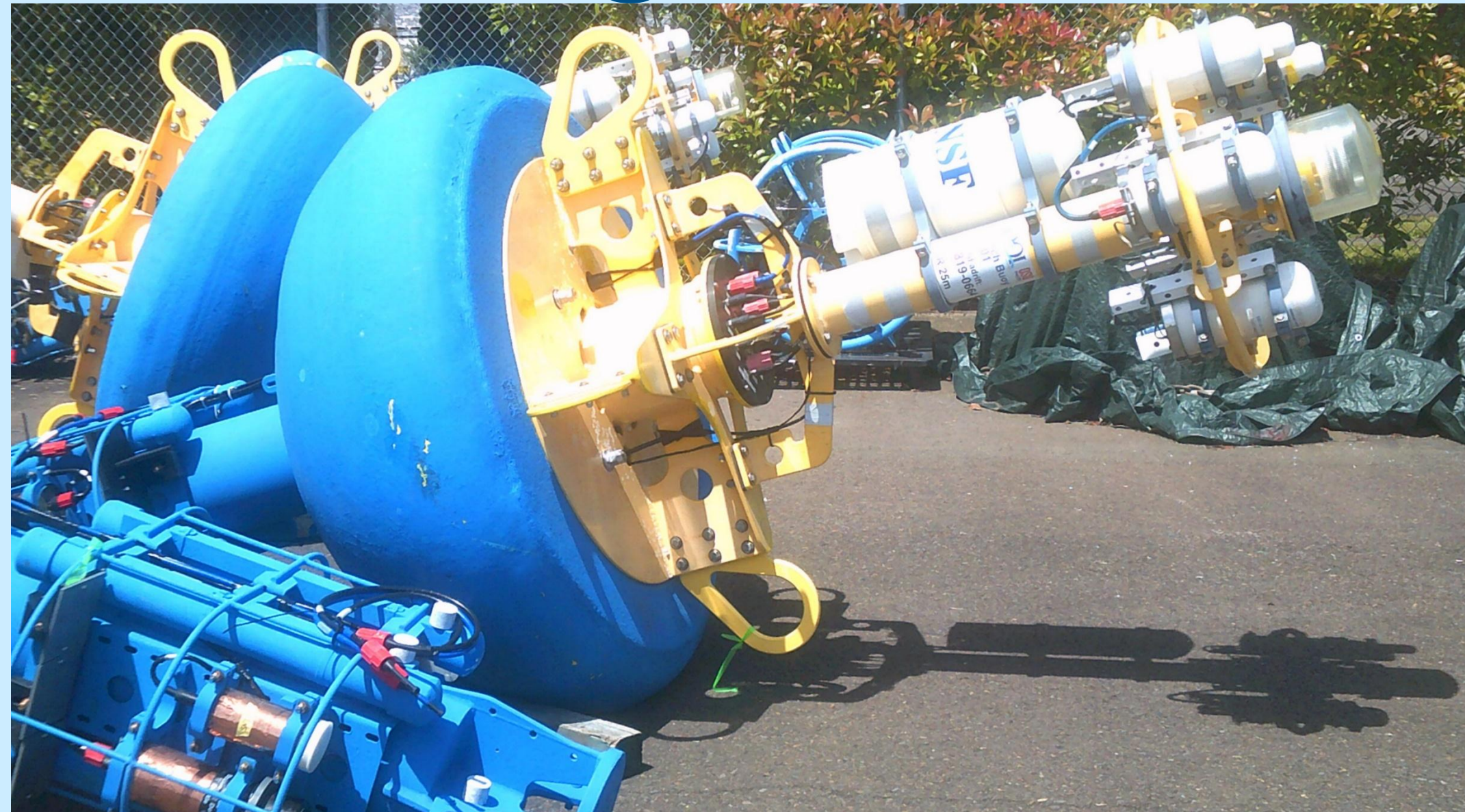
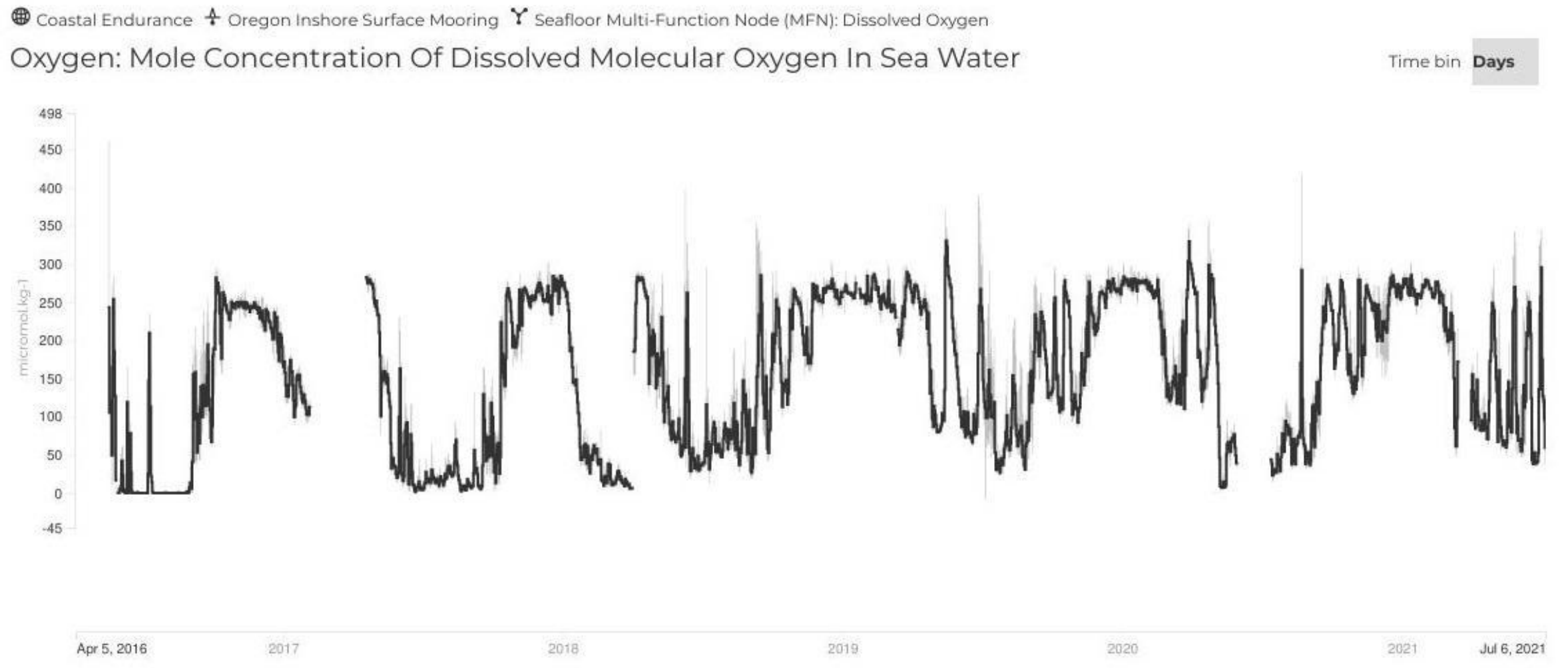

**Application of diaper cream on acoustic transducers to prevent biofouling**

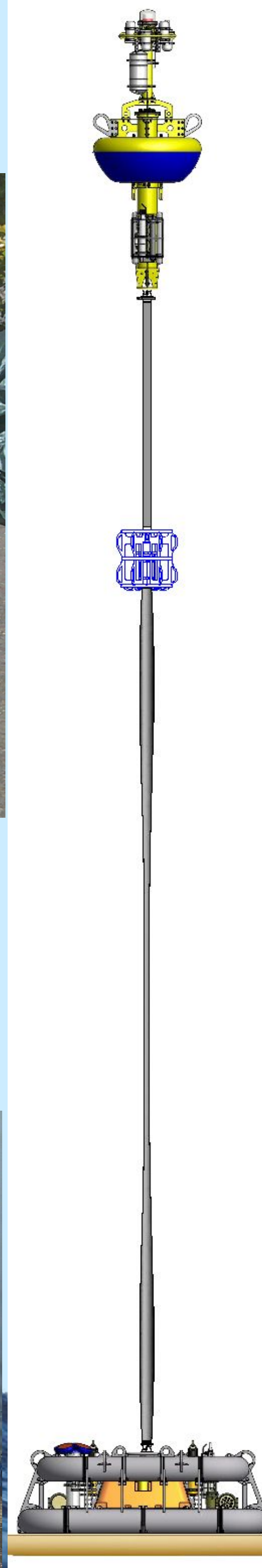



# Coastal Surface Moorings

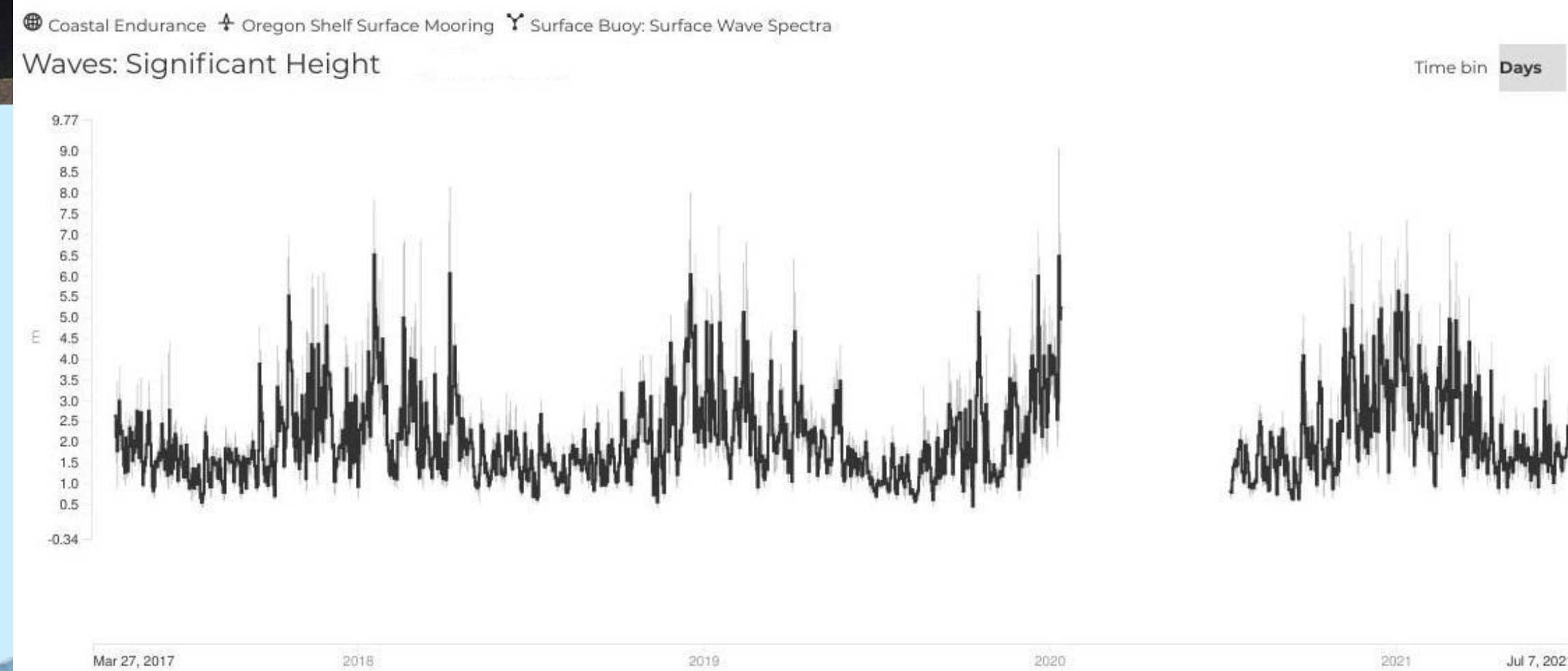
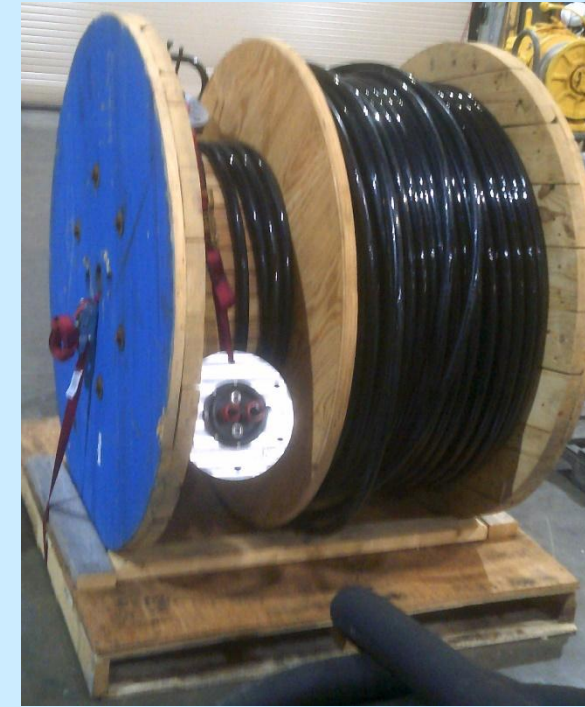



# Coastal Surface Moorings

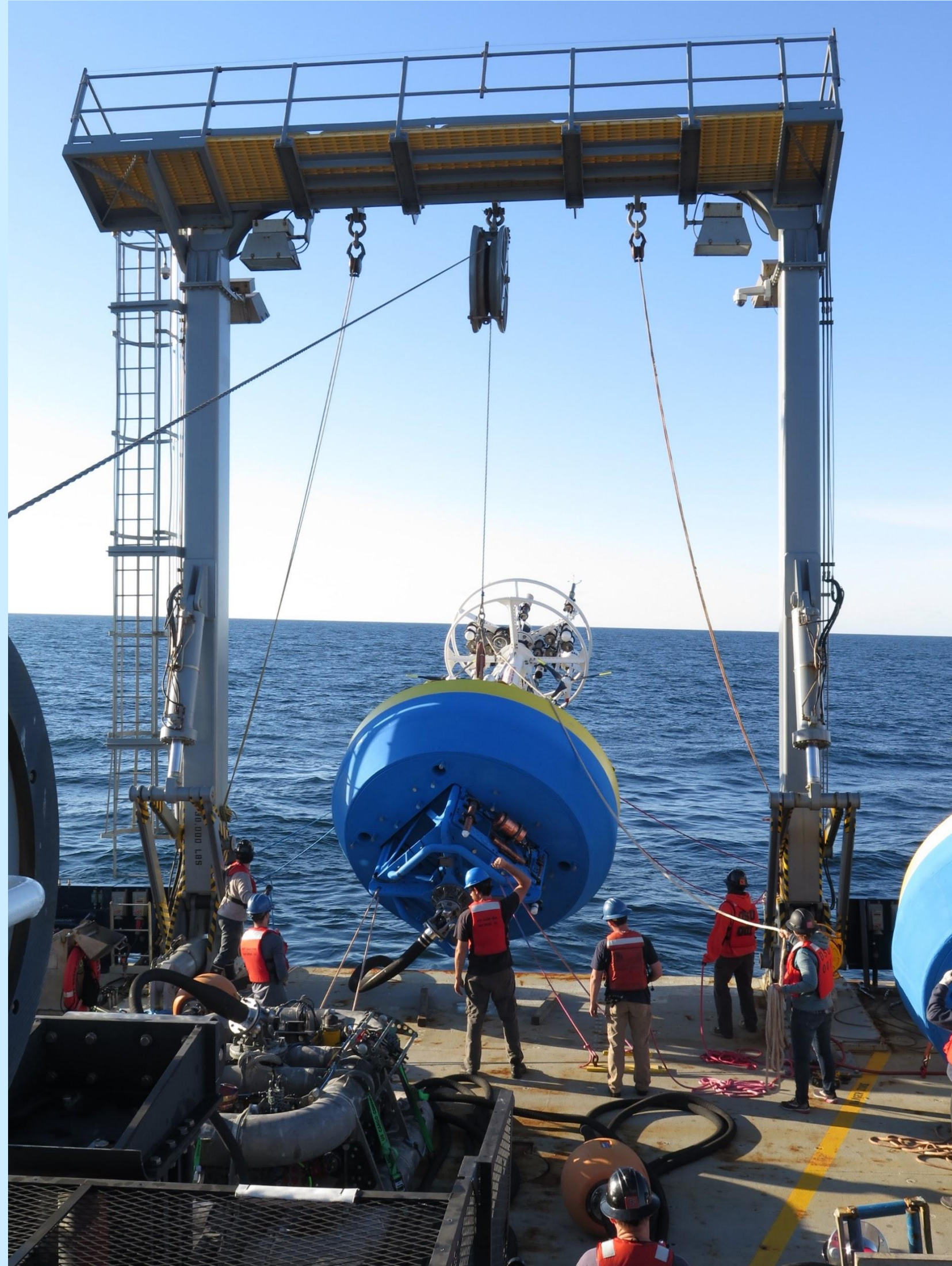

**Large vessel needed for deployment**



**Biofouling**